

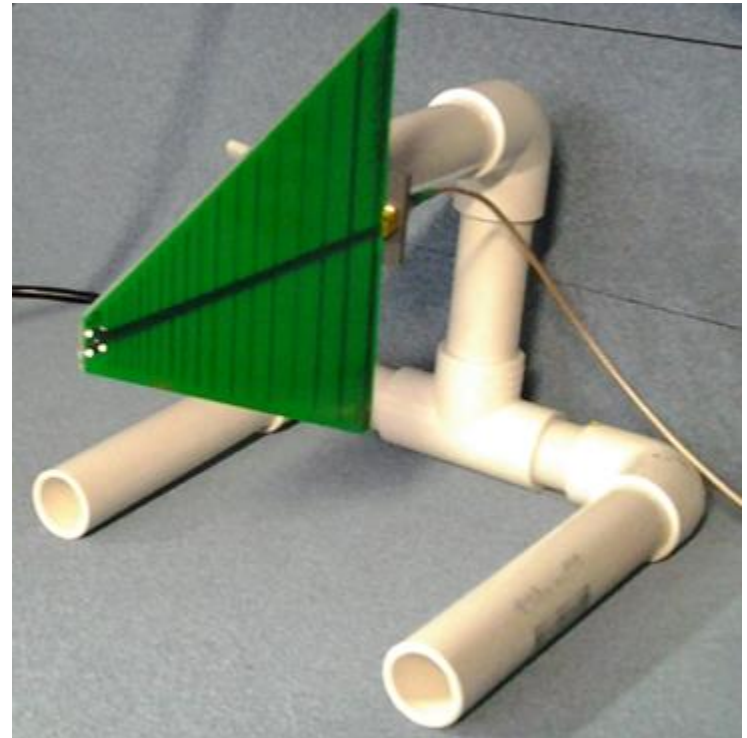

octoBox Isolation Measurement

October 2014



octoBox Isolation Measurements

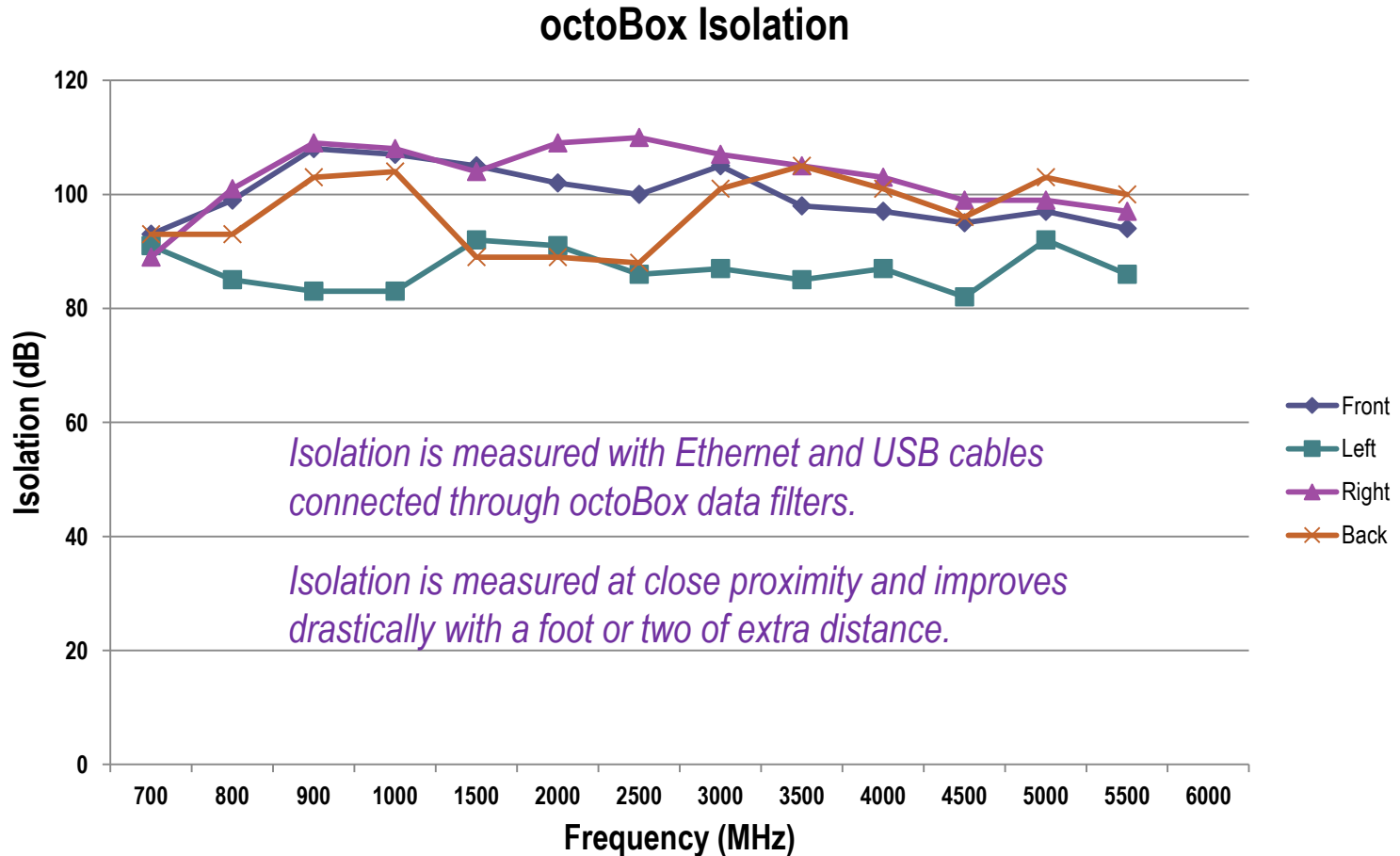

Worst case isolation is at the left side honeycomb vent ('Left' curve)

Isolation Test Setup

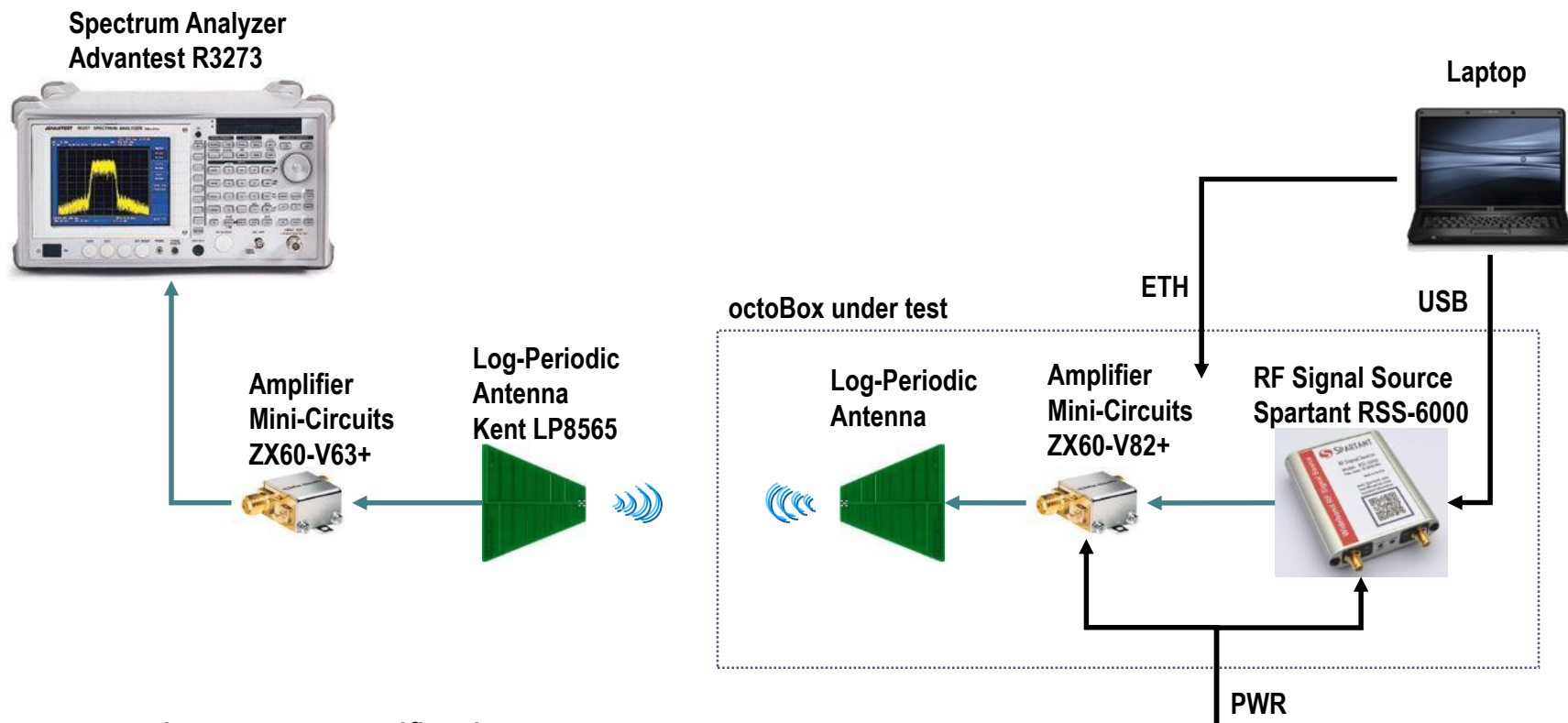

Equipment and antenna specifications

http://www.octoscope.com/English/Products/octoBox_Stackable/octoBox_Stackable.html

http://www.testequipmentconnection.com/specs/ADVANTEST_R3273.PDF

<http://www.spartant.com/download/spartant-rss-6000.pdf>

<http://www.minicircuits.com/pdfs/ZX60-V63+.pdf>

<http://www.minicircuits.com/pdfs/ZX60-V82+.pdf>

<http://www.wa5vjb.com/pcb-pdfs/LP8565.pdf>

Test Procedure

1. Take a reference measurement with the octoBox door open and with TX and RX antennas in close proximity
2. Close the octoBox door and perform measurements at different orientations of octoBox with respect to RX antenna, which is connected to the Spectrum Analyzer
3. Record and plot the measurements for each orientation

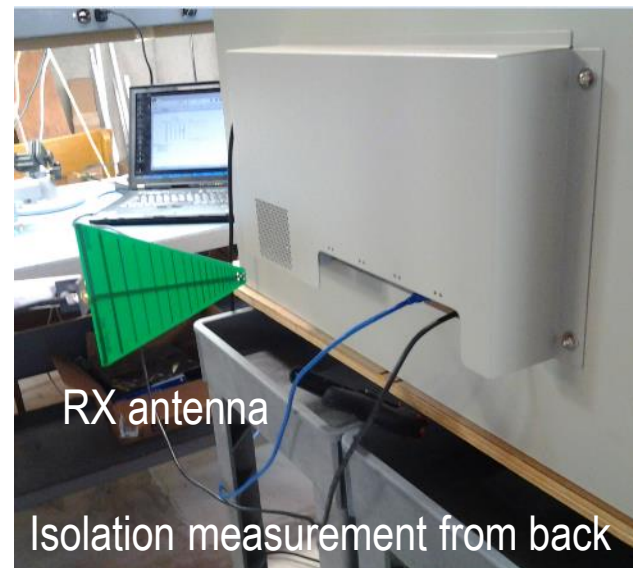
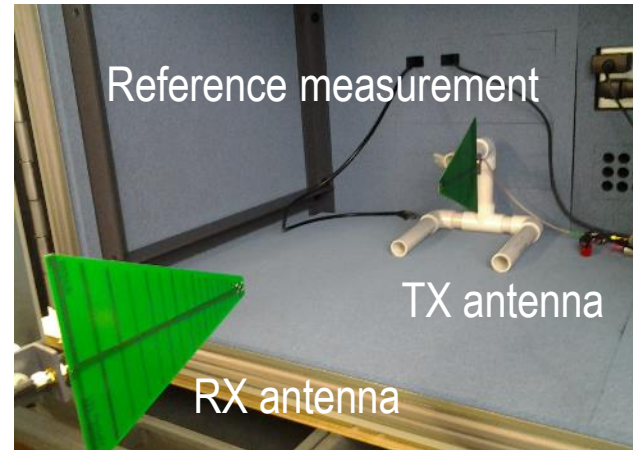

Reference Level Measurement

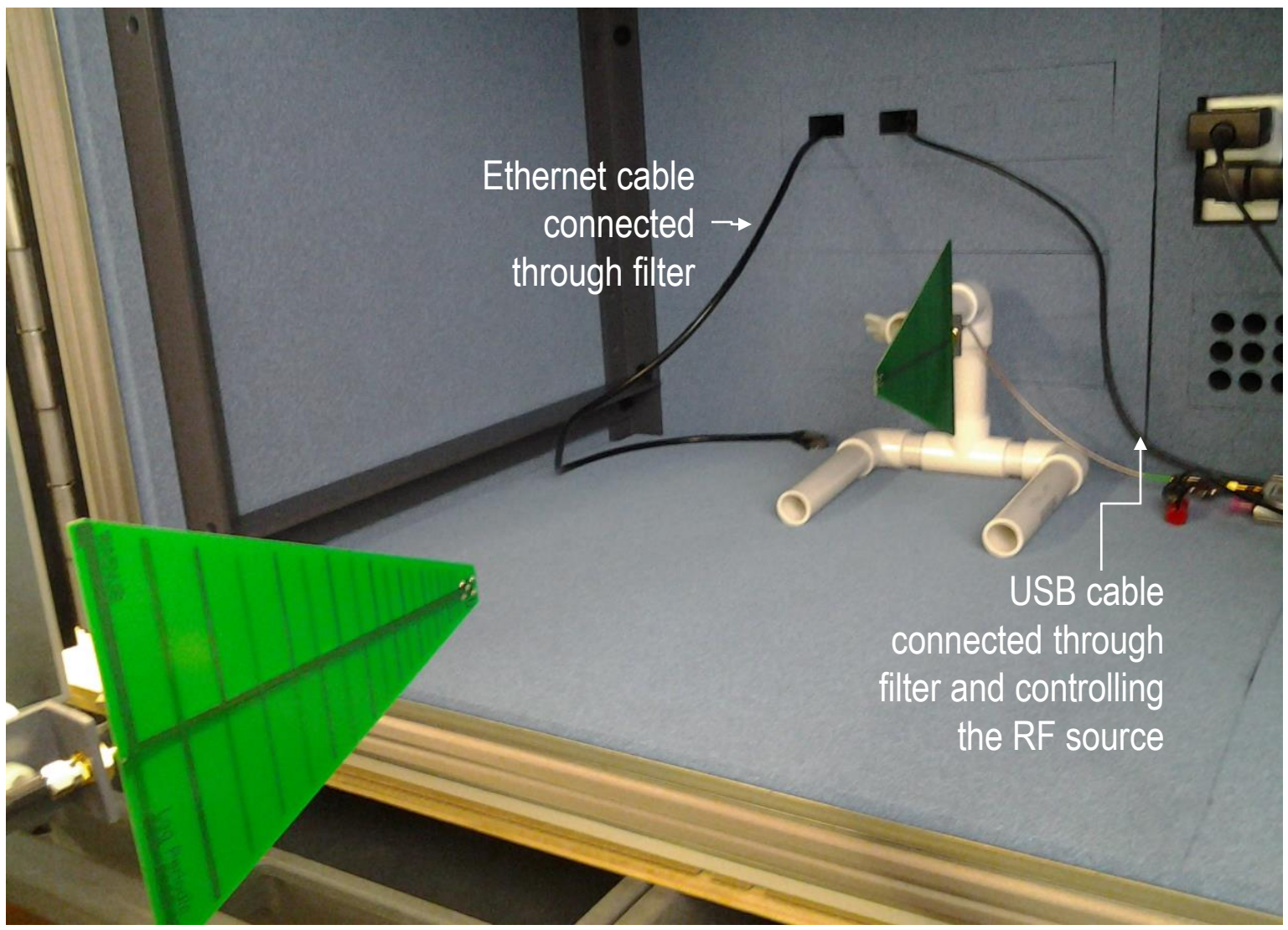

Ethernet cable
connected
through filter →

USB cable
connected through
filter and controlling
the RF source

Internal Antenna and Signal Generator

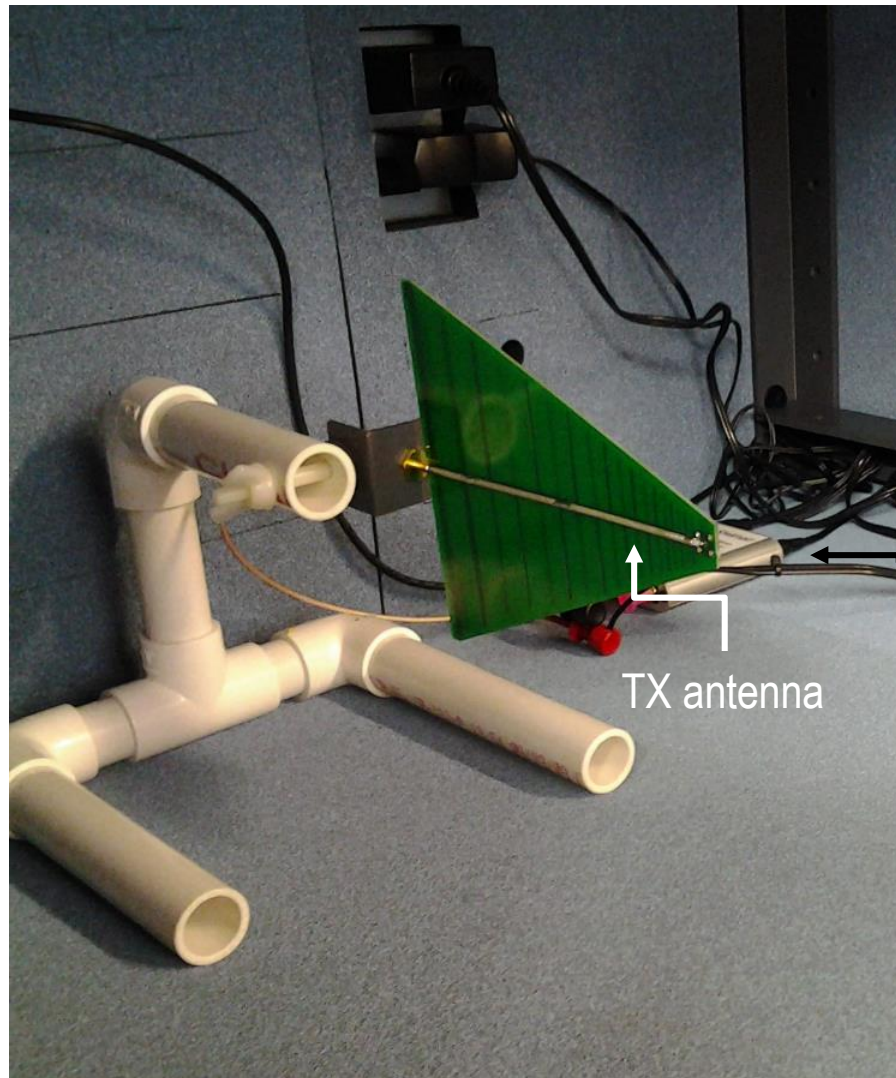

RF Signal Source

TX antenna

Spectrum Analyzer Measurement

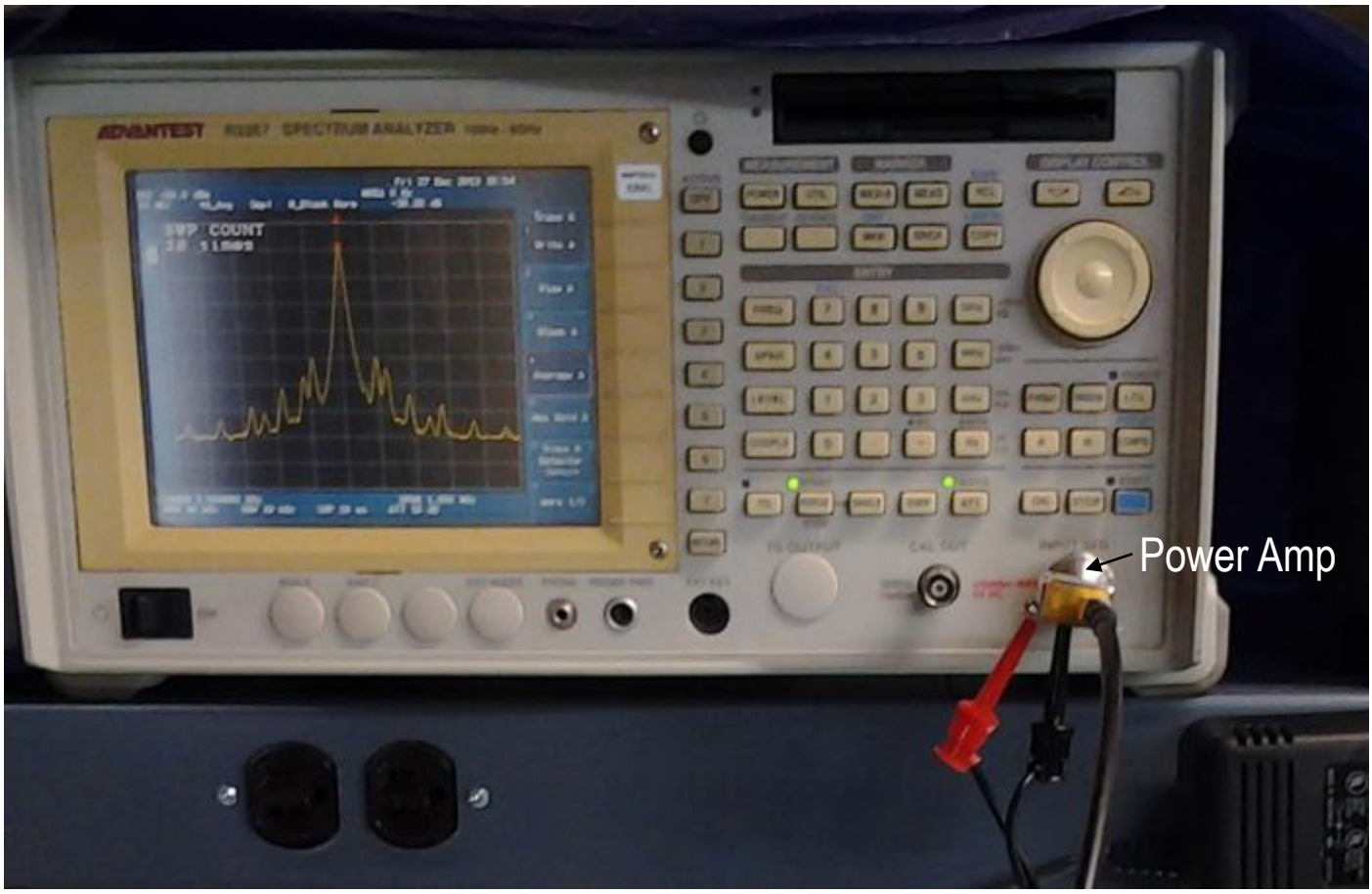

Isolation Measurement at Filter Inputs

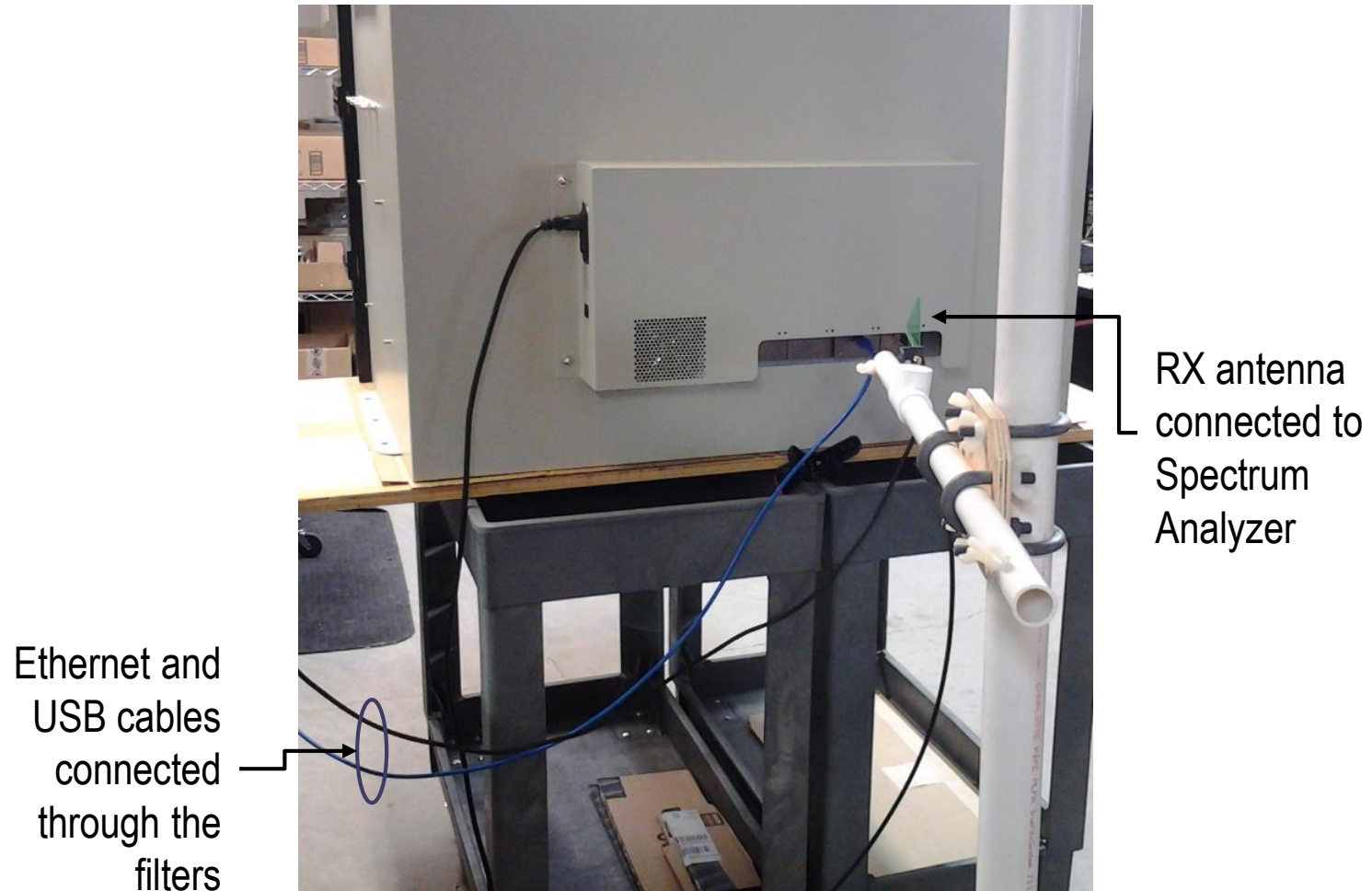

Isolation Measurement at Filter Inputs (close-up)



Isolation Measurement at Vent (Worst Point)

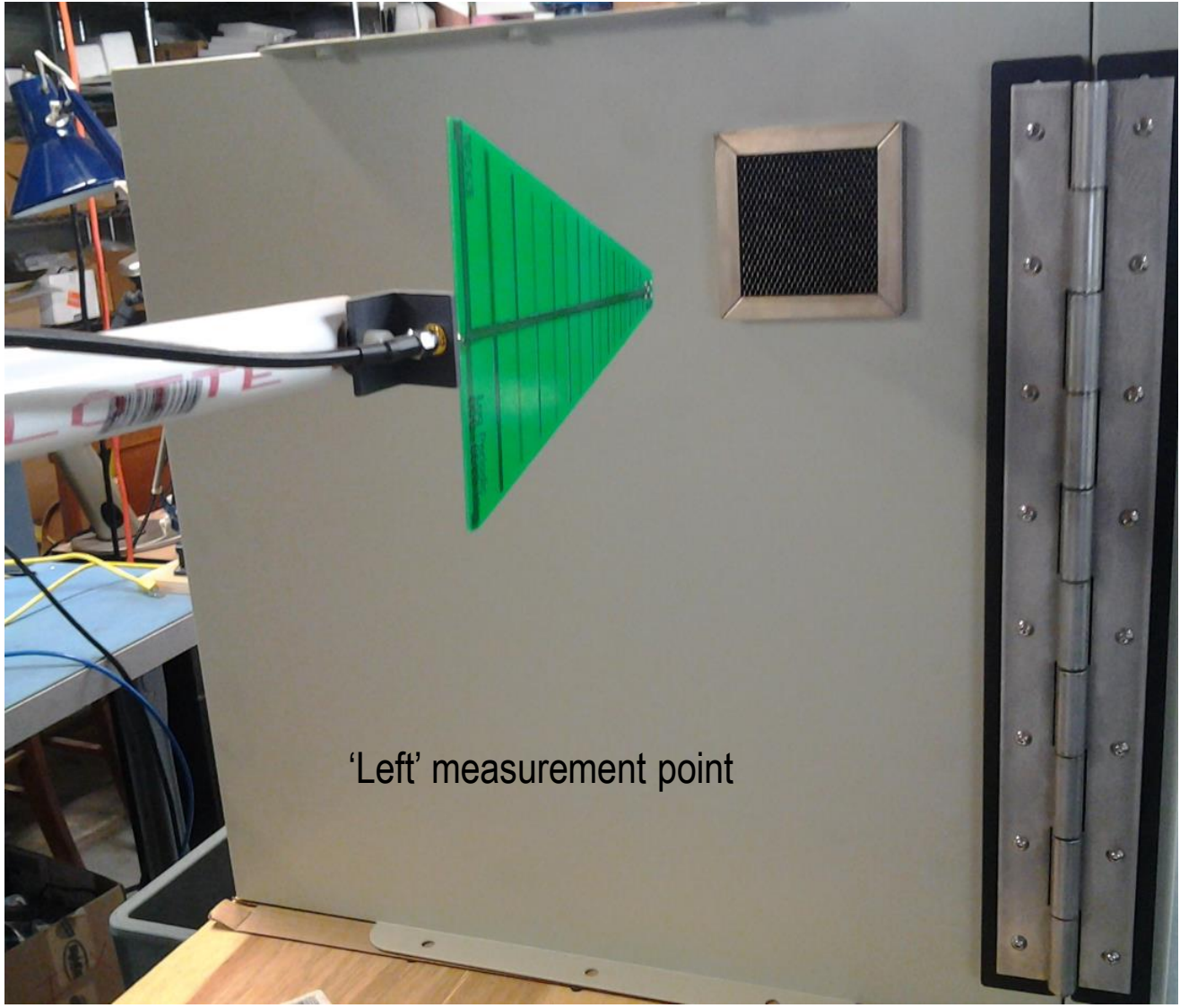

'Left' measurement point

Summary

- Isolation of octoBox has been measured at close proximity. Interference is undetectable in real-life environments when the source of interference is further away than in the measurements shown here.
- octoBox interference is measured with data cables connected through filters, which shows real-life performance of octoBox.
- octoBox typical isolation is about 100 dB and worst case isolation is better than 80 dB at close proximity.

- View octoBox information
 - http://www.octoscope.com/English/Products/octoBox_MPE/octoBox_MPE.html
- View our publications, including articles, white papers, test reports and online tutorials
 - <http://www.octoscope.com/English/Resources/Articles.html>
- Contact
 - sales@octoscope.com
 - +1.978.222.3114

Thank you!